

An Overview of MODIS Radiometric Calibration and Characterization

Xiaoxiong XIONG^{*1} and William BARNES²

¹*Earth Sciences Directorate, NASA/Goddard Space Flight Center, Greenbelt, MD 20771, USA*

²*University of Maryland, Baltimore County, Baltimore, MD 21250, USA*

(Received 5 June 2005; revised 25 August 2005)

ABSTRACT

The Moderate Resolution Imaging Spectroradiometer (MODIS) is one of the key instruments for NASA's Earth Observing System (EOS), currently operating on both the Terra and Aqua satellites. The MODIS is a major advance over the previous generation of sensors in terms of its spectral, spatial, and temporal resolutions. It has 36 spectral bands: 20 reflective solar bands (RSB) with center wavelengths from 0.41 to 2.1 μm and 16 thermal emissive bands (TEB) with center wavelengths from 3.7 to 14.4 μm , making observations at three spatial resolutions: 250 m (bands 1–2), 500 m (bands 3–7), and 1km (bands 8–36). MODIS is a cross-track scanning radiometer with a wide field-of-view, providing a complete global coverage of the Earth in less than 2 days. Both Terra and Aqua MODIS went through extensive pre-launch calibration and characterization at various levels. In orbit, the calibration and characterization tasks are performed using its on-board calibrators (OBCs) that include a solar diffuser (SD) and a solar diffuser stability monitor (SDSM), a v-grooved flat panel blackbody (BB), and a spectro-radiometric calibration assembly (SRCA). In this paper, we present an overview of MODIS calibration and characterization activities, methodologies, and lessons learned from pre-launch characterization and in-orbit operation. Key issues discussed in this paper include in-orbit efforts of monitoring the noise characteristics of the detectors, tracking the solar diffuser and optics degradations, and updating the sensor's response versus scan angle. The experiences and lessons learned through MODIS have played and will continue to play major roles in the design and characterization of future sensors.

Key words: EOS, remote sensing, Terra, Aqua MODIS, sensor, calibration, radiometry

1. Introduction

The Earth Observing System (EOS) is the centerpiece of NASA's Earth Science Enterprise (ESE). Its overall goal is to enhance the scientific understanding of the Earth's land, oceans, and atmosphere, and the natural and human-induced effects on the global environment and climate changes. The Terra and Aqua spacecraft, launched in December 1999 and May 2002, respectively, are two of the major contributors to the EOS.

The Terra spacecraft carries five Earth observing instruments: (1) Advanced Spaceborne Thermal Emission and Reflection Radiometer (ASTER), (2) Clouds and the Earth's Radiant Energy System (CERES), (3) Moderate Resolution Imaging Spectroradiometer (MODIS), (4) Multi-angle Imaging Spectro-Radiometer (MISR), and (5) Measurements

of Pollution in the Troposphere (MOPITT). Carefully registered data products from simultaneous observations allow the EOS instrument teams to develop scientific approaches to better understand specific problems. There are six instruments on Aqua: (1) Atmospheric Infrared Sounder (AIRS), (2) Advanced Microwave Scanning Radiometer for EOS (AMSR-E), (3) Advanced Microwave Sounding Unit (AMSU), (4) CERES, (5) Humidity Sounder for Brazil (HSB), and (6) MODIS. As a cornerstone instrument for the EOS, MODIS is operated on both Terra and Aqua (Salomonson et al., 2002; Barnes et al., 2002; Parkinson, 2003).

The MODIS was designed and developed based on the desire of the science community to collect continuous global data for the studies of both short- and long-term changes in the Earth system. Its spectral bands and spatial resolutions were carefully selected in order

*E-mail: Xiaoxiong.xiong.1@gsfc.nasa.gov

to continue and enhance the observations of legacy sensors, such as the National Oceanic and Atmospheric Administration (NOAA) Advanced Very High Resolution Radiometer (AVHRR), the Landsat Thematic Mapper, the Nimbus 7 Coastal Zone Color Scanner (CZCS), and NOAA's High Resolution Infrared Radiation Sounder (HIRS). MODIS has 36 spectral bands: 20 bands with wavelengths from 0.41 μm to 2.2 μm are the reflective solar bands (RSB) and the 16 bands with wavelengths from 3.5 μm to 14.5 μm are the thermal emissive bands (TEB). It has three nadir spatial resolutions: 250 m for bands 1–2, 500 m for bands 3–7, and 1 km for bands 8–36. The equator crossing time of the Terra spacecraft orbit is 1030 LST descending southwards and that of the Aqua spacecraft is 1330 LST ascending northwards. With complementing morning and afternoon observations, the Terra and Aqua MODIS have greatly enhanced the ability to monitor the global environment and climate changes.

There are approximately 40 science data products generated from the observations of all the MODIS instruments. To ensure the quality of the data products, both Terra and Aqua MODIS went through extensive pre-launch calibration and characterization, including various tests at the component level, sub-system level, and thermal vacuum (TV) system level. In orbit, the instrument is calibrated and characterized using its on-board calibrators: a solar diffuser (SD) and a solar diffuser stability monitor (SDSM), a v-grooved flat panel blackbody (BB), and a spectro-radiometric calibration assembly (SRCA) (Barnes et al, 1998; Guenther et al., 1998; Xiong et al., 2003a; Xiong et al., 2005a; Che et al., 2003).

This paper provides an overview of MODIS pre-launch and in-orbit calibration and characterization activities as well as the level 1B (L1B) algorithms that convert instrument responses (digital numbers) to the calibrated data products (radiance and reflectance). It focuses on the radiometric calibration issues of both RSB and TEB. In-orbit monitoring of the detectors' responses and noise characterization, solar diffuser degradation, and the response versus scan angle (RVS) are discussed. Examples of both Terra and Aqua MODIS in-orbit performance are also presented. Topics related to instrument spectral and spatial calibration and characterization are not discussed in this paper. The experiences and lessons learned from MODIS instrument design, pre-launch and in-orbit calibration and characterization can be applied to future sensors in remote sensing, such as the Visible Infrared Imaging Radiometer Suite (VIIRS) for the National Polar-orbit Operational Environmental Satellite System (NPOESS) and the NPOESS Preparatory Project

(NPP) missions.

2. Instrument background

2.1 Spectral bands and spatial resolutions

Two MODIS instruments were built based on the design specifications listed in Table 1. The protoflight model (PFM) is on board the Terra satellite, and therefore is referred to as Terra MODIS. For the same reason, the flight model 1 (FM1) is referred to as Aqua MODIS. Each MODIS has 36 spectral bands with wavelengths from 0.41 to 14.5 μm and three different nadir spatial resolutions. The 250 m resolution bands 1–2 have 40 detectors per band, the 500 m resolution bands 3–7 have 20 detectors each, and the 1 km resolution bands 8–36 have 10 detectors each. Bands 13 and 14 make observations with both high and low gains using a time-delay and integration (TDI) approach from a pair of detector arrays. Each 1 km resolution data sample in bands 8–36 corresponds to one along-track detector and one along-scan frame of data. MODIS maps into four 500 m resolution data samples in bands 3–7 with two along-track detectors and two along-scan sub-samples each, or sixteen 250 m resolution data samples in bands 1–2 with four along-track detectors and four along-scan sub-samples each. Bands 1–19 and 26, with wavelengths from 0.41 μm to 2.2 μm , are the reflective solar bands (RSB) and bands 20–25 and 27–36, with wavelengths from 3.5 to 14.5 μm , are the thermal emissive bands (TEB).

2.2 Focal plane assemblies (FPAs)

The 36 spectral bands (490 detectors) are located, according to their wavelengths, on four focal plane assemblies (FPAs): visible (VIS), near infrared (NIR), short- and mid-wave infrared (SMIR), and long-wave infrared (LWIR). The detectors of each band are aligned in the along-track direction. The VIS and NIR detectors are photovoltaic (PV) silicon hybrids and the SMIR detectors are PV HgCdTe hybrids. The LWIR FPA consists of PV HgCdTe detector arrays for bands 27–30 and photoconductive (PC) HgCdTe detectors for bands 31–36. The SMIR and LWIR FPAs are operated at 83K in orbit controlled by a radiative cooler, while the VIS and NIR are uncooled FPAs.

2.3 On-board calibrators (OBCs)

MODIS on-board calibrators (OBCs), shown in Fig. 1, include a solar diffuser (SD) plate made of space-grade Spectralon materials, a solar diffuser stability monitor (SDSM), a v-grooved blackbody (BB), and a spectro-radiometric calibration assembly (SRCA). The sensor's view through the space view (SV) port provides a zero signal reference. The SD/SDSM system is used for the radiometric calibra-

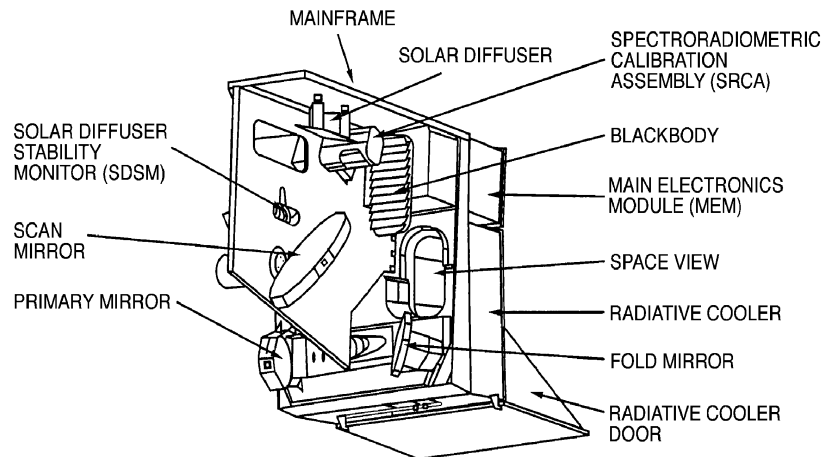

Fig. 1. MODIS scan cavity and on-board calibrators.

tion of the reflective solar bands (RSB) and the BB for the thermal emissive bands (TEB). The SDSM itself is a ratioing radiometer that is used to monitor on-orbit degradation of the SD bi-directional reflectance factor (BRF). The SRCA, consisting of its own sources (a monochromator/optical relay system and a collimator), is used primarily for the spatial (all 36 bands) and spectral (RSB-only due to source limits) characterization. It can also provide a limited capability for monitoring RSB radiometric stability.

2.4 Instrument observations: scans and swath

MODIS makes Earth view (EV) observations over a $\pm 55^\circ$ field-of-view (FOV) range relative to the instrument nadir in the cross-track direction using a two-sided scan mirror that rotates at 20.3 r min^{-1} (or a scan period of 1.478 s). Each scan, of either mirror side 1 or mirror side 2, the sensor views the on-board calibrators and the Earth view consecutively, collecting 50 (SD), 10 (SRCA), 50 (BB), 50 (SV), and 1354 (EV) frames of data samples for each 1 km resolution detector. The number of data samples is doubled

for the 500 m resolution detectors and quadrupled for the 250 m resolution detectors. With the spacecraft (Terra and Aqua) orbiting at an altitude of 705 km, the MODIS produces a swath of 2330 km along the scan by 10 km (at nadir) along the track for each scan, and thus a complete global coverage is achieved in less than 2 days.

3. Pre-launch calibration and characterization

3.1 Pre-launch measurements

Both PFM and FM1, or Terra and Aqua MODIS, went through extensive pre-launch radiometric, spatial, and spectral calibration and characterization activities. Some of these activities were performed at different levels and under different conditions, such as at the ambient sub-system (modular) level and the thermal vacuum system level. In addition, the sensors' near field response (NFR), response versus scan angle (RVS), and polarization sensitivity were carefully examined. Based on the problems identified and lessons

Table 1. MODIS design specifications.

Orbit:	705 km, 1030 LST descending southward or 1330 LST ascending northwards, sun-synchronous, near-polar, circular
Scan rate:	20.3 r min^{-1} , cross track
Swath dimension:	2330 km (cross track) by 10 km (along track at nadir)
Telescope:	17.78 cm diam. Off-axis, afocal (collimated), with intermediate field stop
Size:	1.0 m \times 1.6 m \times 1.0 m
Weight:	250 kg
Power:	225 W (orbital average)
Data rate:	11 Mbps (peak daytime)
Quantization:	12 bits
Spatial resolution:	250 m (bands 1–2), 500 m (bands 3–7),
(at nadir)	1000 m (bands 8–36)
Design life:	5 years

Table 1. Continued.

Primary use	Band	Bandwidth ¹	Spectral radiance ²	Required SNR ³
Land/cloud/aerosols boundaries	1	620–670	21.8	128
	2	841–876	24.7	201
Land/cloud/aerosols properties	3	459–479	35.3	243
	4	545–565	29	228
	5	1230–1250	5.4	74
	6	1628–1652	7.3	275
	7	2105–2155	1	110
Ocean color/phytoplankton/ biogeochemistry	8	405–420	44.9	880
	9	438–448	41.9	838
	10	483–493	32.1	802
	11	526–536	27.9	754
	12	546–556	21	750
	13	662–672	9.5	910
	14	673–683	8.7	1087
	15	743–753	10.2	586
Atmospheric water vapor	16	862–877	6.2	516
	17	890–920	10	167
	18	931–941	3.6	57
	19	915–965	15	250
Primary use	Band	Bandwidth ²	Spectral radiance ²	Required NE Δ T(K) ⁴
Surface/cloud temperature	20	3.660–3.840	0.45	0.05
	21	3.929–3.989	2.38	0.2
	22	3.929–3.989	0.79	0.07
	23	4.020–4.080	0.17	0.07
Atmospheric temperature	24	4.433–4.498	0.59	0.25
	25	4.482–4.549	0.59	0.25
Cirrus clouds/water vapor	26	1.360–1.390	6	150 (SNR) ³
	27	6.535–6.895	1.16	0.25
	28	7.175–7.475	2.18	0.25
Cloud properties	29	8.400–8.700	9.58	0.05
Ozone	30	9.580–9.880	3.69	0.25
Surface/cloud temperature	31	10.780–11.280	9.55	0.05
	32	11.770–12.270	8.94	0.05
Cloud top altitude	33	13.185–13.485	4.52	0.25
	34	13.485–13.785	3.76	0.25
	35	13.785–14.085	3.11	0.25
	36	14.085–14.385	2.08	0.35

¹Bands 1 to 19, nm; bands 20–36 μ m
²(W m⁻² sr⁻¹ μ m⁻¹)
³SNR=signal-to-noise ratio
⁴NE Δ T=Noise-equivalent temperature difference

Performance goal is 30%–40%
better than required

learned from the MODIS PFM calibration and characterization, improvements were made in the FM1 design and characterization.

The system level radiometric calibration and characterization were performed in a thermal vacuum (TV) environment at three instrument temperature plateaus (cold, nominal, and hot). Key activities included detectors' response, non-linearity, sensitivity to the focal

plane and instrument temperatures, and noise characterization. The calibration source for the reflective solar bands (RSB) was a 100cm diameter spherical integrating source (SIS-100) and that for the thermal emissive bands (TEB) was a large aperture blackbody calibration source (BCS).

The spatial characterization was performed using an integration-and-alignment collimator (IAC) to

measure each detector's instantaneous field-of-view (IFOV), band-to-band registration (BBR), line spread function (LSF), and modulation transfer function (MTF). The spectral characterization was made using a spectral measurement assembly (SpMA), equivalently a double-grating monochromator with its own calibration and reference sources. The key parameters derived from the spectral measurements include each detector's relative spectral response (RSR), the center wavelength (weighted over RSR) and bandwidth, and the out-of-band (OOB) RSR. The pre-launch IAC and SpMA results are used as the reference values (offsets) for the on-orbit SRCA spatial and spectral characterization.

In the following, we provide a brief summary of key RSB and TEB pre-launch radiometric calibration parameters that are used in orbit for calibration or in the L1B algorithms. Additional information on MODIS instrument pre-launch calibration and characterization can be found in a number of reports (Xiong et al., 2002a; Xiong et al., 2002b; Guenther et al., 2002).

3.2 RSB pre-launch calibration and characterization

Pre-launch calibration of MODIS reflective solar bands (bands 1–19 and 26) was performed using the SIS-100 as the calibration source. The SIS-100 was traceable to the irradiance standard (FEL lamp) from the National Institute of Standards and Technology (NIST). The detectors' responses to various known SIS radiance levels were characterized at three instrument temperature plateaus, producing temperature correction coefficients used in the in-orbit calibration algorithm. The same datasets were also used to evaluate the detectors' dynamic range, nonlinearity, and signal-to-noise ratios (SNRs). MODIS electronics and signal processing sub-systems were built with redundancy. In addition to the comprehensive sensor characterization at all radiance levels using the primary electronic configuration, limited testing (a subset of the radiance levels) was performed using the redundant electronic configuration.

In orbit, the radiometric calibration coefficients for the reflective solar bands (RSB) are derived from each detector's response to the Sun-illuminated diffuser panel, made of space-grade Spectralon with a near Lambertian reflectance profile in the RSB spectral range. The most important parameter of the solar diffuser (SD) is its bi-directional reflectance factor (BRF). For each MODIS, the SD BRF was carefully characterized before launch by the instrument vendor using a comparison approach with reference samples traceable to the NIST reflectance standards. The SD BRF measurements were made at six wavelengths and at nine illuminating directions to cover the anticipated

range that would be observed during in-orbit calibration. An interpolation from the polynomial fitting values of the SD BRF was made for each reflective solar band (RSB) (Xiong et al., 2003b).

MODIS makes EV observations with a scan mirror that covers a ± 55 scan angle range, relative to the instrument nadir. Each of the 1354 EV data frames corresponds to a different angle of incidence (AOI) to the scan mirror between 10.5° and 65° . Since the calibration is performed at a fixed AOI (at SD view), the sensor's response versus scan angle (RVS) must be applied to the EV data collected at different AOIs. The RSB RVS was characterized using the SIS-100. Instead of the many different radiance levels used in the radiometric calibration, the RVS measurements need many different illuminating angles under the same test conditions. This was achieved by putting MODIS on a rotary table with its nadir direction in the horizontal plane so that the radiant flux from the SIS (fixed) can illuminate the scan mirror at different angles of incidence. The RVS was characterized for each band (averaged over detectors) and each mirror side, fitted to a quadratic function, and applied to the L1B calibration.

3.3 TEB pre-launch calibration and characterization

TEB radiometric calibration was similar to that performed for the RSB at cold, nominal, and hot instrument temperature plateaus using both primary and redundant electronics. Instead of the SIS-100, the source used for the TEB calibration was a large aperture blackbody calibration source (BCS). It was operated in a temperature range from 170 K to 340 K providing multiple radiance levels (21 for the comprehensive test and 11 for the limited test). The BCS temperature was measured by thermistors traceable to the NIST temperature scale. Another blackbody, designed to operate at extremely low temperature, was used to simulate the deep space background, thus called the space view source (SVS). Both the BCS and SVS were inside the thermal vacuum chamber during the TEB system level radiometric calibration.

All of the thermal emissive bands are located on the cold focal plane assemblies (SMIR and LWIR FPA). During the pre-launch TEB system level radiometric calibration, three different FPA temperatures (83 K, 85 K, and 88 K) were used to characterize the TEB detectors' temperature sensitivity. Unlike the RSB, the TEB calibration algorithm is based on a quadratic relationship between the sensor's digital response and the input radiance. This algorithm was applied to the pre-launch calibration and characterization as well as to the in-orbit calibration.

The TEB RVS characterization was performed in an ambient environment using a similar setup to the

RSB RVS measurements with the SIS replaced by the BCS. A bench test cooler was used to cool the SMIR and LWIR FPA and a charge subtraction technique was used to prevent detector saturation. Due to test difficulties, only FM1 had successful RVS characterization. The PFM RVS at launch was constructed from parameters derived from FM1 RVS and the reflectance measured from the PFM scan mirror witness sample.

4. In-orbit calibration and characterization

The MODIS L1B (Terra and Aqua) algorithms convert the sensors' digital response to the scene top of the atmosphere (TOA) reflectance factors for the RSB and the in-band spectral radiance for both the RSB and TEB. The calibration accuracy requirements (1σ) at the typical scene radiance (Table 1) are $\pm 2\%$ for the RSB reflectance factors and $\pm 5\%$ for the RSB radiance product. For the TEB radiance product, the requirements are $\pm 1\%$ except $\pm 0.75\%$ for band 20, $\pm 10\%$ for band 21 (a fire detection low gain band), and $\pm 0.5\%$ for bands 31 and 32 (for sea surface temperature).

The MODIS in-orbit calibration and characterization are performed using its on-board calibrators, including a solar diffuser (SD) and a solar diffuser stability monitor (SDSM), a blackbody (BB), and a spectro-radiometric calibration assembly (SRCA). The instrument in-orbit spatial and spectral (RSB only) characterization was performed by the SRCA. This paper primarily focuses on the radiometric calibration of MODIS RSB by the SD/SDSM system and the TEB by the OBC BB. The SD/SDSM calibration for the RSB is usually performed weekly during the first year of in-orbit operation and then reduced to a bi-weekly schedule. The RSB calibration data is analyzed offline and the look-up tables (LUTs) derived from the SD/SDSM observations are updated as necessary into the L1B code. The TEB calibration is performed on a scan-by-scan basis and needs less frequent LUT updates. For information on MODIS L1B calibration algorithms and LUT updates, please see <http://www.mcst.ssa.gov/mcstweb/L1B/product.html> or contact the MODIS Characterization Support Team (<http://www.mcst.ssa.gov/mcstweb/info/mcststaff.html>).

4.1 RSB calibration algorithm

The TOA reflectance factor is the primary L1B data product for the RSB. It is calculated in the L1B using a simple linear algorithm by (Xiong et al., 2002a)

$$\rho_{EV} \cos(\theta_{EV}) = m_1 \cdot d_{n,EV}^* \cdot d_{ES,EV}^2, \quad (1)$$

where $\rho_{EV} \cos(\theta_{EV})$ is the reflectance factor, θ_{EV} is the solar zenith angle of the EV pixel, m_1 is the calibration coefficient, $d_{ES,EV}$ is the Earth-Sun distance in AU at the time of the EV observation, and $d_{n,EV}^*$ is the

sensor's digital response to the EV target corrected for the instrument background, the viewing angle, and the instrumental temperature effect. It is computed by

$$d_{n,EV}^* = d_{n,EV} \cdot (1 + k_{INST} \cdot \Delta T_{INST,EV}) / A_{RVS,EV}, \quad (2)$$

where $d_{n,EV}$ is the difference between the sensor's raw digital response to the EV and to the SV ($D_{n,EV} - D_{n,SV}$). The instrument temperature correction coefficient, k_{INST} , is determined from pre-launch tests, ΔT_{INST} is the difference between the instrument in-orbit temperature and its pre-launch reference value, and $A_{RVS,EV}$ is the response versus scan angle at the EV AOI. The initial RVS was from pre-launch measurements and its value is updated from in-orbit characterization. The calibration coefficient m_1 is determined from SD observations by

$$m_1 = \frac{\rho_{SD} \cos(\theta_{SD})}{d_{n,SD}^* \cdot d_{ES,SD}^2} \cdot \Gamma_{SDS} \cdot \Delta_{SD}, \quad (3)$$

where ρ_{SD} is the SD BRDF (pre-launch), $d_{n,SD}^*$ is the corrected detector response to the SD, and $d_{ES,SD}$ is the Earth-Sun distance in AU at the time of the SD measurements. An SD degradation factor Δ_{SD} is used to correct the SD reflectance in-orbit degradation. It is determined by the SDSM during each SD calibration. For the high gain bands (bands 8–16), a retractable solar diffuser screen (SDS) is used to attenuate the direct sunlight in the SD calibration. Thus an SDS vignetting function, Γ_{SDS} , is applied. The Γ_{SDS} is derived from in-orbit characterization.

Equations (1) and (3) are essentially the same, except for the SD degradation and SDS vignetting function in the SD calibration. The calibration is performed for each band, detector, sub-sample (for sub-kilometer resolution bands), and mirror side (BDSM). MODIS L1B also produces a radiance product for the RSB. For the SWIR bands (5–7, and 26), a thermal leak correction is applied to their responses (Xiong et al., 2002a).

4.2 TEB calibration algorithm

The TOA radiance, L_{EV} , is the primary data product for the MODIS TEB. It is calibrated in the L1B using a quadratic algorithm (Xiong et al., 2002b), namely

$$\begin{aligned} & A_{RVS,EV} \cdot L_{EV} + (A_{RVS,SV} - A_{RVS,EV}) \cdot L_{SM} \\ & = a_0 + b_1 \cdot d_{n,EV} + a_2 \cdot d_{n,EV}^2, \end{aligned} \quad (4)$$

where $d_{n,EV}$ is the detector's EV response with instrument background subtracted, the offset term a_0 and nonlinear term a_2 are updated periodically using in-orbit BB warm-up and cool-down cycles, and the dominant linear coefficient b_1 is determined at each scan from the sensor's response to the BB. The L_{SM}

term is the scan mirror emission. It cannot be completely canceled from the background subtraction due to the fact that the EV and SV are at different AOIs with different RVSs. The scan mirror emission is calculated using Planck's equation averaged over the relative spectral response (RSR) of each TEB detector. The temperature of the scan mirror is determined from the telemetry data. The linear coefficient b_1 is computed at each scan by

$$\begin{aligned} & A_{RVS,BB} \cdot \varepsilon_{BB} \cdot L_{BB} + (A_{RVS,SV} - A_{RVS,BB}) \cdot L_{SM} \\ & + A_{RVS,BB} \cdot (1 - \varepsilon_{BB}) \cdot \varepsilon_{CAV} \cdot L_{CAV} \\ = & a_0 + b_1 \cdot d_{n, BB} + a_2 \cdot d_{n, BB}^2. \end{aligned} \quad (5)$$

This equation is nearly identical to Eq. (4). The extra term L_{CAV} represents the scan cavity thermal emission reflected from the OBC BB. The emissivities of the BB and the scan cavity, ε_{BB} and ε_{CAV} , were determined from pre-launch calibration and characterization. If the BB has perfect emissivity ($\varepsilon_{BB} = 1$), then the cavity contribution disappears. The in-orbit calibration source is a v-grooved blackbody with 12 embedded thermistors. The thermistors are calibrated to the NIST temperature scale. The OBC emissivity was determined before launch using the response of the MODIS detectors to the BCS and to the OBC BB. This was performed under several operational configurations and radiance levels. The BB cycle provides the TEB responses over BB temperatures (or radiances) from 270 K to 315 K and thus the capability of updating the offset and nonlinear terms in the quadratic algorithm.

5. In-orbit performance

The reflective solar bands (RSB) calibration [Eq. (3)] is based on the sensor's response to the on-board solar diffuser (SD) with a known bi-directional reflectance factor (BRF). Clearly the calibration and data product quality for the MODIS RSB strongly depends on the capability and accuracy of tracking its SD in-orbit degradation, which is primarily caused by its repeated solar exposure. Figure 2 shows examples of Terra MODIS SD degradation at several wavelengths monitored by the SDSM detectors (Xiong et al., 2001). The trending results indicate that the shorter the wavelength, the faster the SD degradation rate. Normally the SD door is opened only during scheduled SD calibration events. The noticeably sharp change of the degradation rate after day 1200 (since the instrument nadir door opening on 24 February 2000) is due to the more frequent solar exposure of the SD when the Terra MODIS SD door was set to and fixed at an open position as the result of an SD screen related anomaly. The other two vertical lines before day 500 marked the time when the Terra MODIS changed its operational

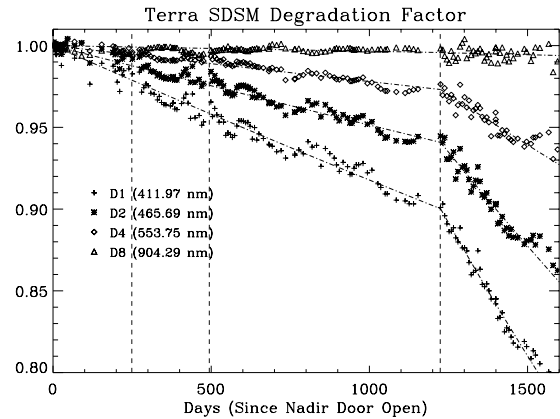

Fig. 2. Terra MODIS solar diffuser (SD) degradation determined by the solar diffuser stability monitor (SDSM) at four different wavelengths.

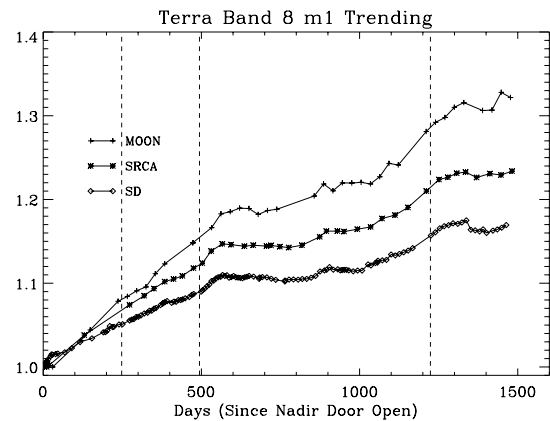

Fig. 3. Terra MODIS band 8 response trending at three different angles of incidence: SD, SRCA, and the Moon (through space view port)

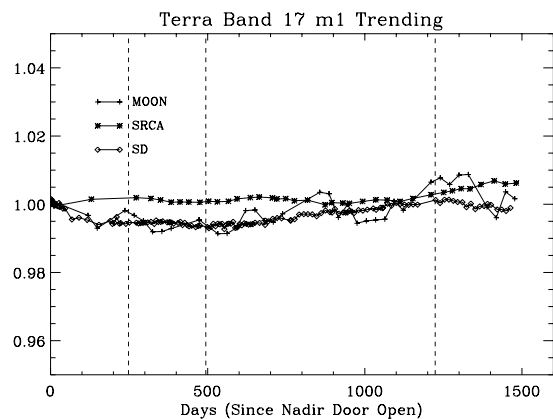

Fig. 4. Terra MODIS band 17 response trending at three different angles of incidence: SD, SRCA, and the Moon (through space view port)

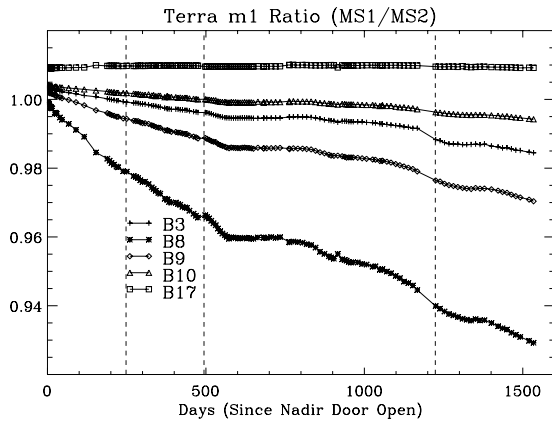

Fig. 5. Terra MODIS RSB response (m_1) difference between two mirror sides for bands 3, 8, 9, 10, and 17.

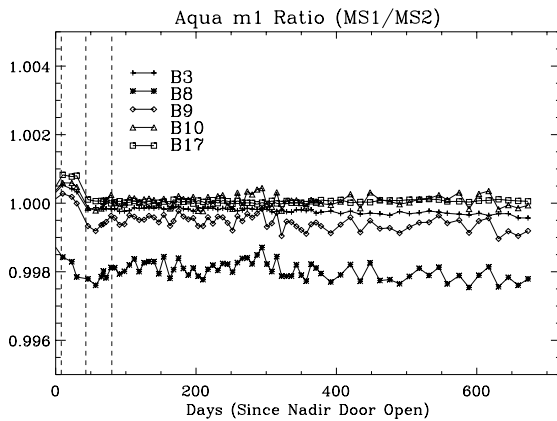

Fig. 6. Aqua MODIS RSB response (m_1) difference between two mirror sides for bands 3, 8, 9, 10, and 17.

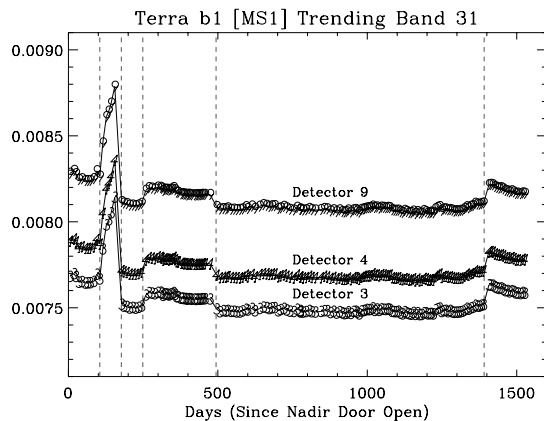

Fig. 7. Terra MODIS TEB response (b_1 of mirror side 1) trending for band 31 (detectors 3, 4, and 9).

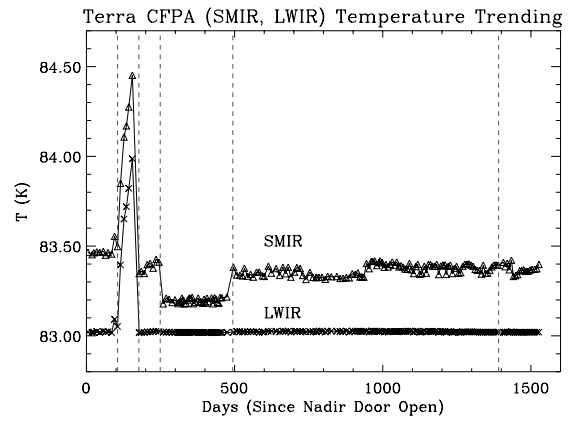

Fig. 8. Temperature trending for Terra MODIS SMIR and LWIR cold focal plane assemblies (CFPAs).

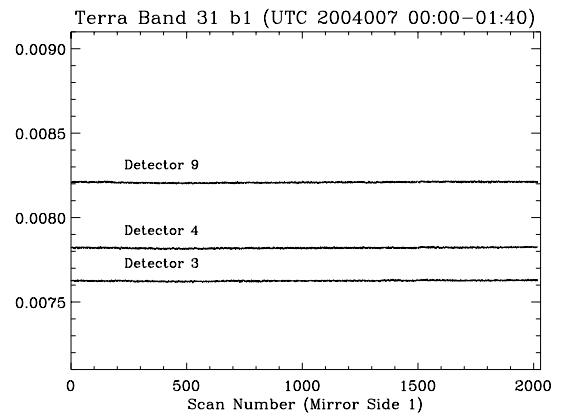

Fig. 9. Terra MODIS band 31 (detectors 3, 4, and 9) scan-by-scan response (b_1).

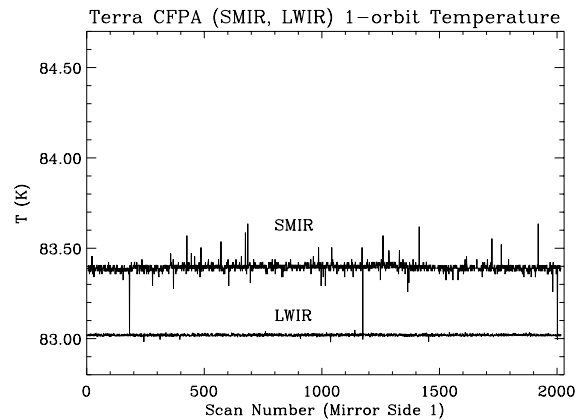

Fig. 10. Terra MODIS SMIR and LWIR temperatures (same date/time as in Fig. 9).

configurations (Barnes et al., 2002). The Aqua MODIS SD degradation trending is very similar to Terra MODIS under the same operating conditions.

The scan mirror's degradation at different AOIs determines the sensor's response versus scan angle (RVS). If in-orbit degradation has the same trend at

different angles, then there is no need for the RVS update. For the reflective solar bands (RSB), the response can be monitored and trended at three different AOIs: SD observations at 50.2° , SRCA at 38° , and lunar observations at 11.2° . Figures 3 and 4 depict the response trending examples for Terra MODIS bands 8 ($0.41 \text{ m}\mu$) and 17 ($0.91 \text{ m}\mu$). For band 8, the response (averaged over all detectors) has significant degradation, and the degradation rate is quite different at the three AOIs. On the other hand, for band 17, the response degradation and the difference among the different AOIs are very small, less than $\pm 1\%$ over four and a half years. Because of this, the SD calibration will not suffice to capture the sensor's response change for bands like Terra MODIS band 8. Their RVSs must be updated in orbit.

For the thermal emissive bands, the relative RVS (mirror side 1 relative to mirror side 2) can be validated and improved in orbit using datasets obtained from scanning the instrument nadir aperture door when it is closed. This was done for both Terra and Aqua MODIS. The absolute RVS can be measured in orbit using datasets collected during the spacecraft deep space maneuvers (Xiong et al., 2005b). This operation has only been executed for the Terra MODIS.

In addition to AOI dependence, the degradation is tracked for each mirror side. In the visible spectral region, the Terra MODIS scan mirror has different degradations between the two mirror sides while the Aqua MODIS scan mirror has nearly the same degradation for both mirror sides during the same period of in-orbit operation. This mirror-side-dependent degradation is illustrated in Fig. 5 for Terra MODIS and Fig. 6 for Aqua MODIS using the ratio of the response from mirror side 1 to that from mirror side 2. For Terra MODIS, the shorter wavelength bands have the larger mirror-side differences.

The thermal emissive bands (TEB) are calibrated using the on-board blackbody (BB). Figure 7 illustrates the long-term stability of Terra MODIS band 31 (detectors 3, 4, and 9) using existing in-orbit response (b_1) trending in which each point is averaged over a 5 minute interval. Notice that the response changes are well matched to the variations of the focal plane temperature in Fig. 8 and to the changes of the operational configuration marked by the vertical lines in the plots. These changes will not impact MODIS TEB calibration since it is performed on a scan-by-scan basis. Figure 9 shows the corresponding short-term stability using the detectors' scan-by-scan responses over an entire orbit. This encompasses about 100 minutes, including both day and night data. The corresponding FPA temperature profile is provided in Fig. 10. Under the same operational conditions, the short- and long-term TEB response is very stable.

Terra and Aqua MODIS each have 490 detectors. Detector noise characterization is constantly performed in orbit. For the RSB, the responses to the SD (with screen and without screen) and the SV are used. For the TEB, the responses to the BB at different temperatures are used. The overall in-orbit performance in this category has been satisfactory for both instruments. Excluding those identified before launch, less than 2% of the detectors have been identified in orbit as being either noisy or inoperable. Additional performance results can be found in our previous reports that have addressed various and specific in-orbit calibration and characterization issues (Guenther et al., 2002; Xiong et al., 2001, 2002a, b, 2003b, c, 2005b).

6. Lessons learned

There have been a number of improvements made in the MODIS FM1 design and its pre-launch calibration and characterization based on the lessons learned from the PFM, including using different electronics combinations. Similarly, Terra MODIS in-orbit lessons and experiences have also benefited Aqua post-launch efforts. Consequently, Aqua MODIS has been performing better in orbit. Because of the similarity of the Visible Infrared Imaging Radiometer Suite (VIIRS) of NPOESS and NPP to the MODIS instrument (same instrument vendor), lessons learned here will provide valuable information for VIIRS (Xiong et al., 2003d).

Prior to spacecraft launch, a few changes were made to both Terra and Aqua MODIS after their thermal vacuum (TV) system level tests. The changes were made either to correct the identified problems or to improve the sensors' performance from the lessons learned from the pre-launch calibration and characterization. Because of these changes, additional post-launch efforts have been made to assure the calibration and characterization quality. This illustrates that the instrument calibration and characterization efforts will not end after pre-launch tests. Thus it is important to keep flexible and sufficient post-launch capability.

In addition, the in-orbit calibration and characterization activities should not just be limited to using its on-board calibrators. MODIS has used regular lunar observations for the RSB radiometric stability trending and detector crosstalk assessment (Sun et al., 2003; Xiong et al., 2002c). The advantage of using the Moon is that it serves as an excellent reference source with extremely stable surface reflectance. One of the important applications of lunar observations is to allow different sensors to compare with each other. Other vicarious calibration efforts, like ground truth validation and inter-comparison among different sensors, also add valuable information (Wu et al., 2003; Thome et al., 2003).

The flexibility and availability of spacecraft maneuvers also enhance the calibration capability. MODIS has performed a number of special characterization activities using spacecraft yaw, pitch, and roll maneuvers. These activities have allowed the MODIS to validate the SD BRF, to derive the SD screen vignetting function, to study SD degradation uniformity, and to determine the TEB RVS.

7. Summary

The MODIS is one of the key instruments for NASA's EOS, designed from legacy sensors with improved spectral, spatial, and temporal resolutions. It is currently operating on both the Terra and Aqua satellites, making complementary morning and afternoon observations and providing the science community with continuous datasets for studying and better understanding the global environment and climate changes. MODIS has 36 spectral bands: 20 reflective solar bands and 16 thermal emissive bands that are calibrated and characterized in-orbit by a set of in board calibrators that include a solar diffuser and solar diffuser stability monitor system, a blackbody, and a spectro-radiometric calibration assembly. This paper has provided details of the MODIS instrument background, including its on-board calibrators and focal plane assemblies. It has presented an overview of MODIS pre-launch and in-orbit calibration and characterization activities and efforts, the L1B calibration algorithms, and lessons learned. The MODIS reflective solar band calibration is reflectance based. The band measurements are calibrated in orbit by the SD/SDSM system using a simple linear algorithm with response changes updated through L1B LUTs. The thermal emissive bands are calibrated on a scan-by-scan basis by the on-board blackbody using a quadratic algorithm. Examples of MODIS in-orbit performance are also provided in this paper, including SD degradation, mirror side response difference, RVS changes for the reflective solar bands, and the detectors' short- and long-term stability for the thermal emissive bands. In general, both Terra and Aqua MODIS have been performing well according to the specified design parameters mainly because of the extensive and constant calibration and characterization efforts. There is no doubt that the experiences and lessons learned from MODIS have addressed the importance of sensor calibration and characterization, from pre-launch and in orbit, and will benefit future remote sensing missions.

Acknowledgments. Authors would like to thank our colleagues at Raytheon Santa Barbara Remote Sensing (SBRS) for sharing their expertise and knowledge and N. Che and K. Chiang of MODIS Characterization Support Team for helping prepare the figures used in this paper.

REFERENCES

- Barnes, W. L., T. S. Pagano, and V. V. Salomonson, 1998: Pre-launch characteristics of the Moderate Resolution Imaging Spectroradiometer (MODIS) on EOS AM-1. *IEEE Trans. Geosci. Remote Sens.*, **36**, 1088–1100.
- Barnes, W. L., X. Xiong, and V. V. Salomonson, 2002: Status of Terra MODIS and Aqua MODIS. Proc. IGARSS, Toronto, Canada, Vol. II, 970–972.
- Che, N., X. Xiong, and W. L. Barnes, 2003: On-orbit spectral characterization of the Terra MODIS reflective solar bands. *Proc. SPIE—Earth Observing Systems VIII*, **5151**, 367–374.
- Guenther, B., G. D. Godden, X. Xiong, E. J. Knight, H. Montgomery, M. M. Hopkins, M. G. Khayat, and Z. Hao, 1998: Pre-launch algorithm and data format for the Level 1 calibration products for the EOS AM-1 Moderate Resolution Imaging Spectroradiometer (MODIS). *IEEE Trans. Geosci. Remote Sens.*, **36**, 1142–1151.
- Guenther, B., X. Xiong, V. V. Salomonson, W. L. Barnes, and J. Young, 2002: On-orbit performance of the Earth Observing System Moderate Resolution Imaging Spectroradiometer: First year of data. *Remote Sens. Environ.*, **83**, 16–30.
- Parkinson, C. L., 2003: Aqua: An Earth-observing satellite mission to examine water and other climate variables. *IEEE Trans. Geosci. Remote Sens.*, **41**, 173–183.
- Salomonson, V. V., W. L. Barnes, X. Xiong, S. Kempfer, and E. Masuoka, 2002: An overview of the Earth Observing System MODIS instrument and associated data systems performance. *Proceedings of IGARSS*, Toronto, Canada.
- Sun, J., X. Xiong, B. Guenther, and W. L. Barnes, 2003: Radiometric stability monitoring of the MODIS reflective solar bands using the Moon. *Metrologia*, **40**, 85–88.
- Thome, K., J. Czaplak-Myers, and S. Biggar, 2003: Vicarious calibration of Aqua and Terra MODIS. *Proc. SPIE—Earth Observing Systems VIII*, **5151**, 395–405.
- Wu, A., C. Cao, and X. Xiong, 2003: Inter-comparison of the 11 μm and 12 μm bands of Terra and Aqua MODIS using AVHRR/NOAA-16/17. *Proc. SPIE—Earth Observing Systems VIII*, **5151**, 384–394.
- Xiong, X., J. Esposito, J. Sun, C. Pan, B. Guenther, and W. L. Barnes, 2001: Degradation of MODIS optics and its reflective solar bands calibration. *Proc. SPIE—Sensors, Systems, and Next Generation Satellite V*, **4540**, 62–70.
- Xiong, X., J. Sun, J. Esposito, B. Guenther, and W. L. Barnes, 2002a: MODIS reflective solar bands calibration algorithm and on-orbit performance. *Proc. SPIE—Optical Remote Sensing of the Atmosphere and Clouds III*, **4891**, 95–104.
- Xiong, X., K. Chiang, B. Guenther, and W. L. Barnes, 2002b: MODIS thermal emissive bands calibration algorithm and on-orbit performance. *Proc. SPIE—Optical Remote Sensing of the Atmosphere and Clouds III*, **4891**, 392–401.

- Xiong, X., J. Sun, K. Chiang, S. Xiong, and W. L. Barnes, 2002c: MODIS on-orbit characterization using the Moon. *Proc. SPIE-Sensors, Systems, and Next Generation Satellites VI*, **4881**, 299–307.
- Xiong, X., K. Chiang, J. Esposito, B. Guenther, and W. L. Barnes, 2003a: MODIS on-orbit calibration and characterization. *Metrologia*, **40**, 89–92.
- Xiong, X., J. Sun, J. Esposito, X. Liu, W. L. Barnes, and B. Guenther, 2003b: On-orbit characterization of a solar diffuser solar diffuser's bi-directional reflectance factor reflectance factor using spacecraft maneuvers. *Proc. SPIE-Earth Observing Systems VIII*, **5151**, 375–383.
- Xiong, X., K. Chiang, J. Sun, N. Che, and W. L. Barnes, 2003c: Aqua MODIS first year on-orbit calibration and performance. *Proc. SPIE-Sensors, Systems, and Next Generation of Satellites IX*, **5234**, 391–399.
- Xiong, X., W. L. Barnes, B. Guenther, and R. E. Murphy, 2003d: Lessons learned from MODIS calibration and characterization. *Advances in Space Research*, **32**, 2017–2122.
- Xiong, X., N. Che, and W. L. Barnes, 2005a: Terra MODIS on-orbit spatial characterization and performance. *IEEE Transactions on Geoscience and Remote Sensing*, **43**, 355–365.
- Xiong X., V. V. Salomonson, K. Chiang, A. Wu, B. Guenther, and W. L. Barnes, 2005a: On-orbit characterization of RVS for MODIS thermal emissive bands. *Proc. SPIE-Passive Optical Remote Sensing of the Atmosphere and Clouds IV*, **5652**, 210–218.